

Digital Pressure Gauge XY-PG200

Typical Feature

- 304 Stainless Steel shell, dial diameter 105mm
- With pressure scale bar, indicating the current pressure percentage
- 5¹/₂-Digits display with high resolution
- Accuracy Level: 0.4%, 0.2%, 0.1% Class (Optional)
- Weld Absolute Pressure, Gauge Pressure and Vacuum Pressure
- Powered by 3 cells AA Battery Power, standby time 18-24 months
- Record Maximum and Minimum pressure data
- 13 pressure Multi-unit switching
(MPa, KPa, Pa, PSI, Bar, KGF /cm², Bar, Mbar, InH₂O, mmHg, Lorr, ATM, mmH₂O)
- One key reset to Zero
- USB and battery dual power supply
- Strong media compatibility, water, oil, gas and others medium without corrosion for stainless steel



Brief Introduction







XY-PG200 is a high precision Digital Pressure Gauge, which is built-in high accuracy pressure sensor. It displays real time pressure data at short response time. The typical characteristics are high accuracy and excellent long-term stability.

The Digital Pressure Gauge has a large size LCD display with 5-Digits. There are 4 buttons on the front panel to control Reset, Backlit display, Power On/Off, Unit converting, low voltage alarm, peak value recording, etc.

It is easy to install in Pipeline, Isolation tank or others connect device, and easy to set up operating parameter. It's should be cold once working condition temperature more than 60oC. It has 304 stainless steel and joint, can be used in measuring gas, liquid, oil and other medium without corrosion for stainless steel, at the same time its shock resistance is very good.

XY-PG200 digital pressure gauge is powered by 3 batteries (AA) or USB connector, with low power consumption and long duration. There are three pressure measurement types: Gauge Pressure, Vacuum Pressure and Absolute Pressure machinal joint include Thread, Flush Diaphragm, Clamp, Flange, Radiator and Differential Two-way Fitting.

Suggested Applications

-  Water Treatment System
-  Water Pump and Air compressor
-  Electromechanical Equipment Automation
-  Engineering Machinery
-  Medical Equipment
-  Hydraulic and Pneumatic Systems
-  Laboratory

Customized Applications

More details for XY-PG200, please contact us.

Specification

Model	XY-PG200
Vacuum Pressure Range	0~-100KPa
Absolute Pressure Range	0~160~250~400KPa;0~1Mpa.
Composite Range	(-0.1~0.1) (-0.1~0.25) (-0.1~0.4) (-0.1~0.6)(-0.1~1.0) (-0.1~2.5) MPa (-2.5~2.5) (-5~5) (-10~10) (-25~25) (-50~50) KPa;
Gauge Pressure Range	(0~160) (0~250) (0~400) (0~600) KPa; (0~1) (0~1.6) (0~60) MPa
Micro-pressure Range	(0~2) (0~5) (0~10) (0~25) (0~50) (0~100) KPa
High pressure Range	(0~100) (0~160) (0~200) MPa
Pressure Type	Gauge Pressure Test, Absolute Pressure Test, Vacuum Pressure Test
Dimension	Diameter Φ105
Overload Capacity	200% (≤10MPa); 150%(>10MPa)
Measurement Medium	Gas or Liquid with Compatibility of SS 304
Accuracy Level	0.1%FS; 0.2%FS; 0.4%FS
Long-Term Stability/Year	Typical: ±0.2% FS;
Sample Frequency	2 times/Second
Operation Temperature	-5~40°C; -20~150°C are customized
Compensation Temperature	0~40°C
Display	5½ digits LCD, white backlit display
EMC	EN61326
Data Record	EEPROM, with Peak value record
Power Supply	3 cells 1.5V AA Battery or USB

Dimension(mm)

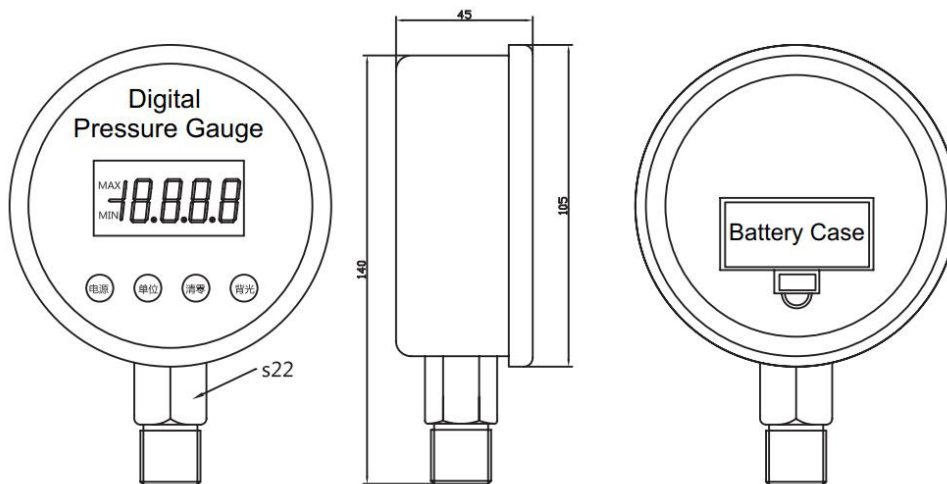

Digital Pressure Gauge (Dial Size 100mm)

Mechanical Connection(mm)

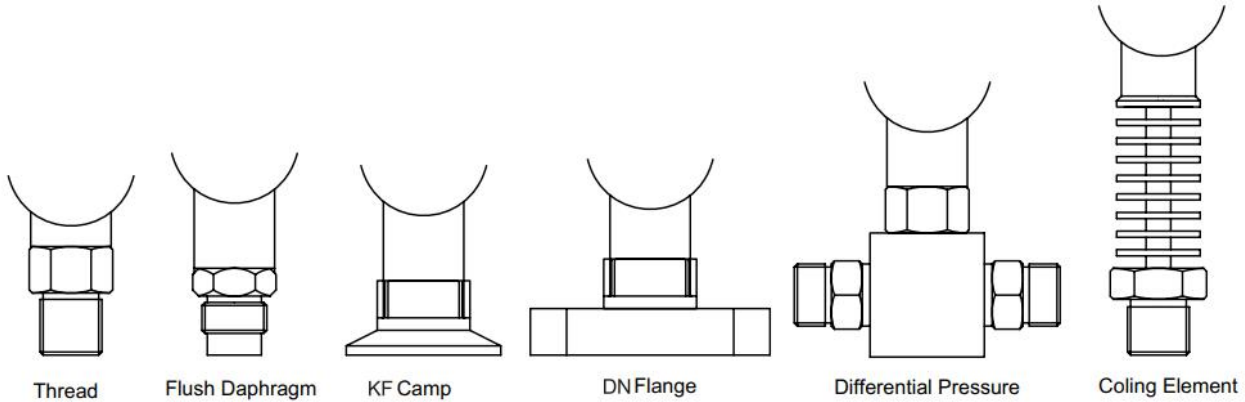

How To Order

XY-	PG	280	E	P	60M	1	P2	J	M3	B1	T1	L				
Category	Type	Setup	Pressure Connection	Pressure Range	Accuracy	Power	Output	Thread	Electrical Connection	Medium Temperature	Additional					
PG	Pressure Gauge	200	High Accuracy	E Lowest Mount	None	General Thread	XX (0-30Pa)	1	0.40%	P0 Battery	R RS485	M1 M20*1.5	B Cable Outlet	T1 -5~40°C	LC LCD Display	
		210	High Accuracy Pressure&Temperature	Z Panel Mount	P	Diaphragm Seals	XB (0-3Bar)	2	0.20%	P2 24V	A 4-20mA	M2 G1/4	C Circular Connector	T2 -20~80°C	LE LED Display	
		270	Explosion-Proof	G Wireless	DP	Differential Pressure	XM (0-30MPa)	3	0.10%	P4 220V	J1 Relay	M3 G1/2	CC Customized	T9 Customized	I1 Explosion-Proof	
		280	80mm Dial Size LCD Display	F Peak Record	KF	Clamp	CC Customized	4	0.50%	P5 380V	J2 Dual Relay	M4 1/2NPT				
		260	60mm Dial Size	V Vacuum Switch	DN	Flange		5	0.25%	P6 12V	CC Customized	M5 1/4NPT				
		300	100mm Dial Size	W Water Pump Switch	9999	Customized		9	Customized	P9 Customized						
		380	80mm Dial Size LED Display													
		560	Digital Remote-transmission													
		625	Contact 60mm Dial Size													
		825	Contact 80mm Dial Size													
925	Contact 90mm Dial Size															
PS	Pressure Switch	628	80mm Dial Size													
		638	80mm Dial Size													
		928	100mm Dial Size													
		650	Switch Box with Plastic Shell													
		600	Switch Box with Full Metal Shell													
700	Mechanical															
PC	Pressure Control	600	80mm Dial Size													
		800	80mm Dial Size													
		900	100mm Dial Size													

Remark: 1. This form is for whole Pressure Measurement and Pressure Control products, please read Product Date Sheet to get reference informations
2. If you may not find right information in this form, Please contact us to get future details

Shanghai XuYan Precision Technology Co., Ltd.

Address: No. 969, YunHan Road Pudong District Shanghai City China

Tel: +86 21 59241315

Email: sales@xvyanprecision.com

Website: www.xvyanprecision.com

Product Manager: Tyler Tou

Cell: +86 189 1797 0680

Email: ttao@Xuyanpercision.com