

## Digital Remote Transmission Pressure Gauge XY-PG560

### Typical Feature

- Stainless steel 304 shell, Dial diameter 60mm
- With 4-Digits LED or LCD Display
- Output RS485(LED Display) or 4-20mA (LCD Display)
- Transmission distance more than 500Meter
- Accuracy level: Pressure 0.25%; 0.5%
- Wide measurement pressure range(-100KPa~60MPa), or customized
- Powered 12-32VDC, Typical 24VDC
- Baud Rate 2400/4800/9600/19200/38400/57600 are optional
- Protection Class IP65
- Strong media compatibility, water, oil, gas and other medium without corrosion in stainless steel



### Brief Introduction









XY-PG560 is a Digital Remote transmission Pressure Gauge, with optional 4-20mA and RS485 output, which is built-in high accuracy pressure sensor. It displays real-time pressure at short response time, the typical characteristics are high accuracy and excellent long-term stability, they are able to remote transmission the signal to more than 500 meters, designed for Automatic System, Frequency Water Supply Equipment, Air Pressure System and Hydraulic Pressure System, it's a very good alternative for Mechanical Remote Transmission Pressure Gauge or alternative for Pressure Transmitters.

Digital Remote transmission Pressure Gauge has LED or LCD display with 4-Digits, display digits are optional too. There are 3 buttons on front panel set up the gauge. It is easy to install in Pipeline, Isolation Tank or other connected device, easy to set up operating parameter. Working condition is -20~80 oC.

It has 304 stainless steel shell and connect joint, can be used in measuring gas, liquid, oil and other medium it has very good shock resistance and long working life.

XY-PG560 Digital Remote transmission Pressure Gauge is powered by 12-32VDC, typical 24VDC. There are Absolute Pressure Test, Gauge Pressure Test, Vacuum Pressure Test, wide Measurement Range. machinal joint include Thread, Flush Diaphragm, Clamp, Flange, Radiator and Differential Two-way Fitting.

### Suggested Applications

-  Automatic System,
-  Frequency Water Supply Equipment,
-  Air Pressure System
-  Hydraulic Pressure System
-  Pressure Container,
-  Air Compressor
-  Automated Machine
-  Heat Pump Industry

Customized Applications

More details for XY-PG560, please contact us.

Specification

<b>Model</b>	<b>XY-PG560</b>
Vacuum Pressure Range	-100KPa~0
Absolute Pressure Range	0~5~10~20~100~1000KPa
Composite range	(-0.1~0.1) (-0.1~0.25) (-0.1~0.4) (-0.1~0.6) (-0.1~1.0) (-0.1~2.5) MPa (-2.5~2.5) (-5~5) (-10~10) (-25~25) (-50~50) KPa
Gauge Pressure Range	-100KPa~0~5~100KPa~1~5~10~25~60MPa
Micro pressure Range	(0~5) (0~10) (0~25) (0~50) (0~100) KPa
General Pressure Range	0~160~250~400~600KPa~1MPa~1.6~100MPa
Pressure Type	Gauge Pressure Test, Absolute Pressure Test, Vacuum Pressure Test
Dimension	Diameter Φ60
Overload Capacity	200%(≤10MPa); 150%(>10MPa)
Measurement Medium	Gas or Liquid with Compatibility of SS 304
Accuracy Level	0.25%FS; 0.5%FS
Long-Term Stability/Year	Typical: ±0.2% FS;
Zero Temperature drift	Typical: ±0.02%FS/°C; Maximum ±0.05%FS/°C
Sensitivity Temperature drift	Typical: ±0.02%FS/°C; Maximum ±0.05%FS/°C
Sample Frequency	≤2mS
Power Supply	12-32VDC (Typical 24V)
Output Single	4-20mA or RS485 Optional
Operation Temperature	-20 ~ 80°C
Compensation Temperature	-10~70°C
IP Protection Class	IP65

Dimension(mm)

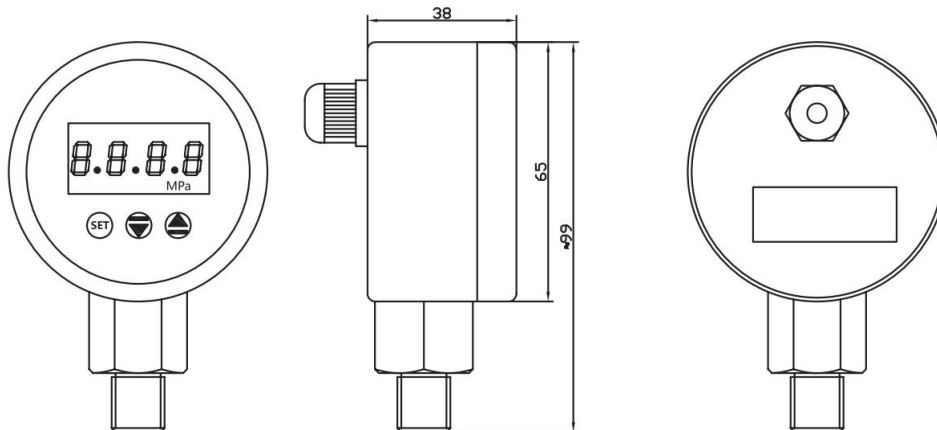

Mechanical Connection(mm)

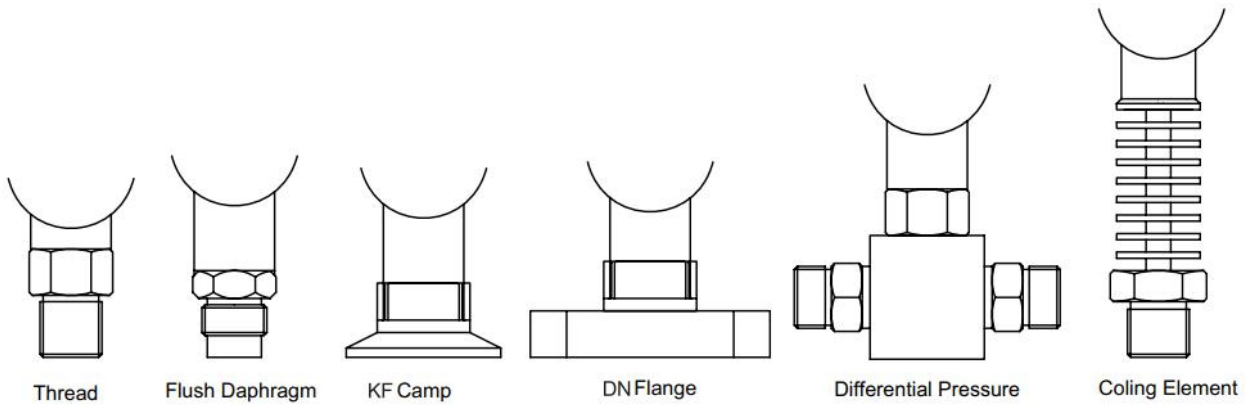

Electrical Connection

<b>4-20mA(Two Wire)</b>	<b>Power Supply(V+)</b>	<b>Red</b>
	<b>Signal(V-)</b>	<b>Black</b>
<b>RS 485 Signal (Four Wire)</b>	<b>Power Positive(V+)</b>	<b>Red</b>
	<b>Power Negative(V-)</b>	<b>Black</b>
	<b>RS485(S+) Green</b>	
	<b>RS485(S-) White</b>	

How To Order

XY-	PG	280	E	P	60M	I	P2	J	M3	B1	T1	L		
	Category	Type	Setup	Pressure Connection	Pressure Range	Accuracy	Power	Output	Thread	Electrical Connection	Medium Temperature	Additional		
PG	Pressure Gauge	200	High Accuracy	E Lower Mount	None	XX (0-XXPa)	1 0.40%	P0 Battery	R RS485	M1 M20*1.5	B Cable Outlet	T1 -5~40°C	LC LCD Display	
		210	High Accuracy Pressure&Temperature	Z Panel Mount	P Diaphragm Thread	XB (0-XXBar)	2 0.20%	P2 24V	A 4-20mA	M2 G1/4	C Circular Connector	T2 -20~80°C	LE LED Display	
		270	Explosion-Proof	G Wireless	DP Differential Pressure	XM (0-XXMPa)	3 0.10%	P4 220V	J1 Relay	M3 G1/2	CC Customized	T9 Customized	T1 Explosion-Proof	
		280	80mm Dial Size LCD Display	F Peak Record	KF Clamp	CC Customized	4 0.50%	P5 380V	J2 Dual Relay	M4 1/2NPT				
		280	80mm Dial Size	V Vacuum Switch	DN Flange		5 0.25%	P6 12V	CC Customized	M5 1/4NPT				
		300	100mm Dial Size	W Water Pump Switch	9999 Customized		9 Customized	P9 Customized		M7 RS1/4				
		380	80mm Dial Size LED Display							M9 Customized				
		560	Digital Remote-transmission											
		625	Contact 60mm Dial Size											
		825	Contact 80mm Dial Size											
PS	Pressure Switch	628	60mm Dial Size											
		828	80mm Dial Size											
		928	100mm Dial Size											
		650	Switch Box with Plastic Shell											
PC	Pressure Control	600	Switch Box with Full Metal Shell											
		700	Mechanical											
		600	60mm Dial Size											
		800	80mm Dial Size											
		900	100mm Dial Size											

Remark: 1. This form is for whole Pressure Measurement and Pressure Control products, please read Product Date Sheet to get reference informations  
2. If you may not find right information in this form, Please contact us to get future details

**Shanghai XuYan Precision Technology Co., Ltd.**

**Address:** No. 969, YunHan Road Pudong District Shanghai City China

**Tel:** +86 21 59241315

**Email:** sales@xvyanprecision.com

**Website:** [www.xvyanprecision.com](http://www.xvyanprecision.com)

**Product Manager:** Tyler Tou

**Cell:** +86 189 1797 0680

**Email:** ttao@Xuyanpercision.com